

RoHS compliant

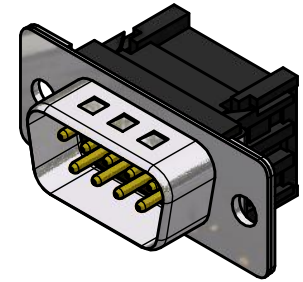
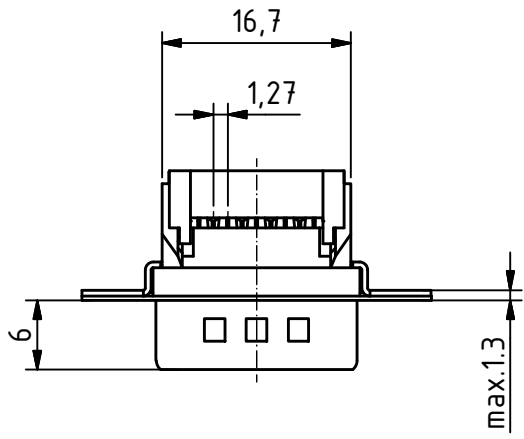
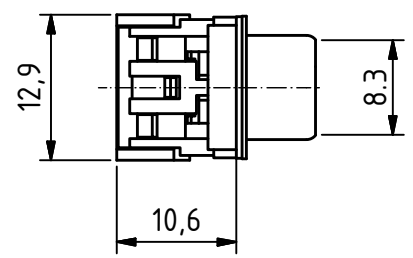
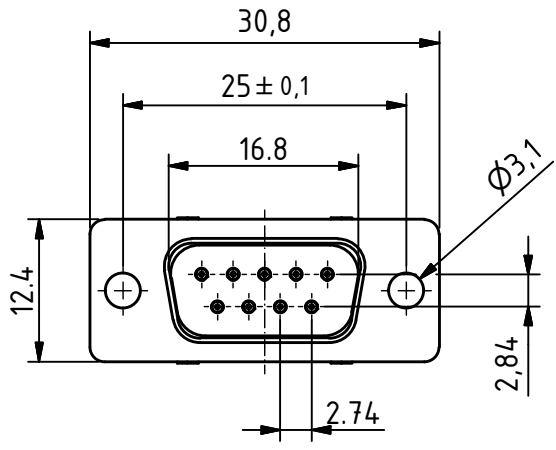

suitable for cable AWG 28-26

MATERIALS

- Insulator: Thermoplastic UL 94-V-0 black
- Contact: Machined / Copper alloy
- Contact finish: Quality class 2
- Shell: Steel tin plated

CHARAKTERISTICS

- Working voltage: 500V for 1 minute
- Current rating: 3A
- Contact resistance: max. 20mΩ
- Insulation resistance: 1000MΩ min.
- Temperature range: -55° to +105°C

General tolerances (Deltron standard)	size in mm	> 30	> 6	> 3	> 0.5
		up to 120	up to 30	up to 6	up to 3
	tolerances	±0.3	±0.2	±0.2	±0.1

	All dimensions in mm	Rev.	Rev.	Rev.	DE017691		
		Rev.	Rev.	Rev.	part no.		
DTS09PFC/2-A				1.5:1 scale	drawn	29.03.2019	rop
					checked		
					approved		
				Industrie Neuhof 8c CH-3422 Kirchberg www.d-sub.swiss		K063479	
						drawing no.	